

WARRANTY: ALL TANKS MUST BE BACKFILLED AND COMPACTED PRIOR TO FILLING OR WARRANTY IS VOID.

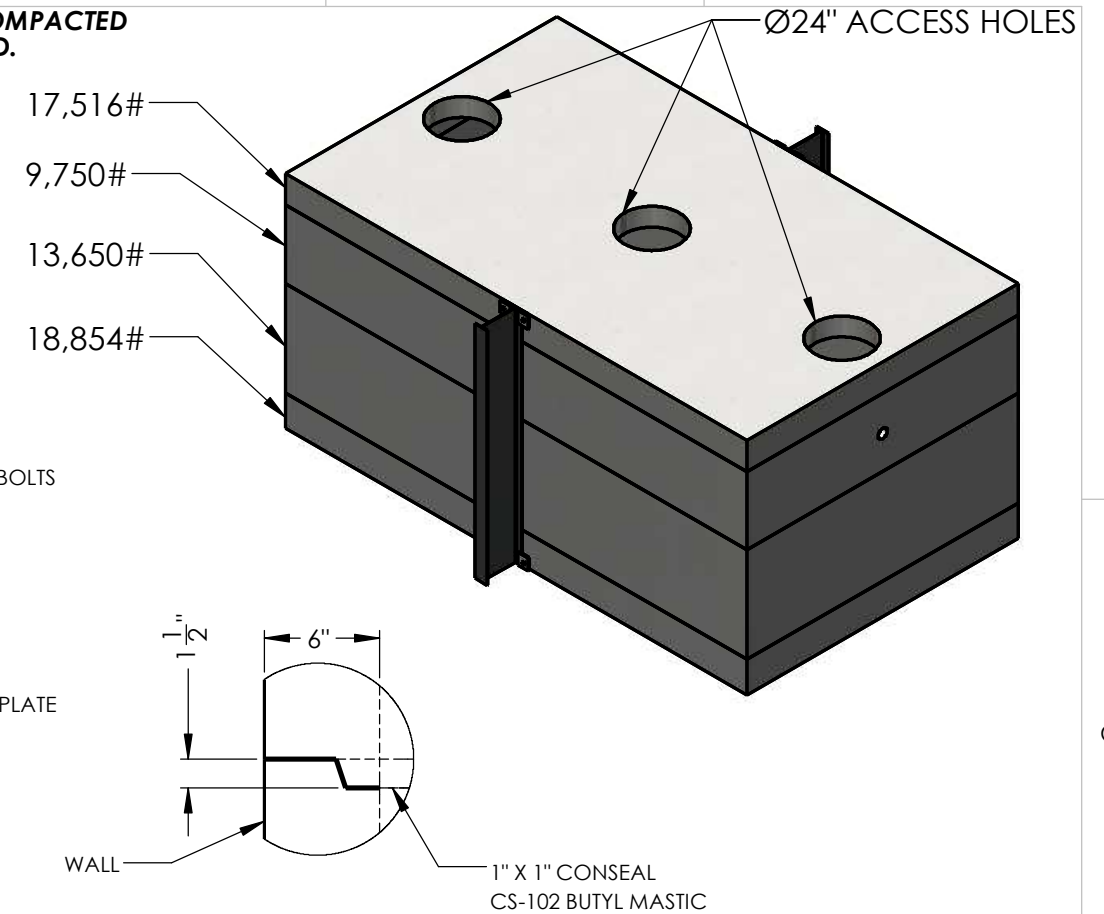

SHIPLAP JOINT DETAIL B

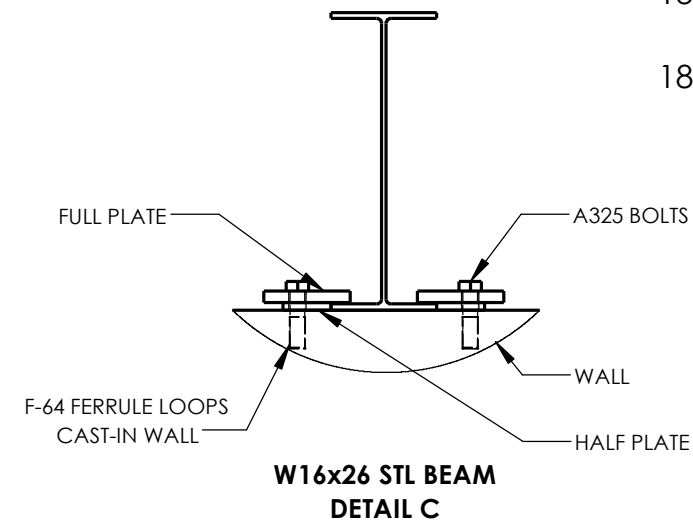
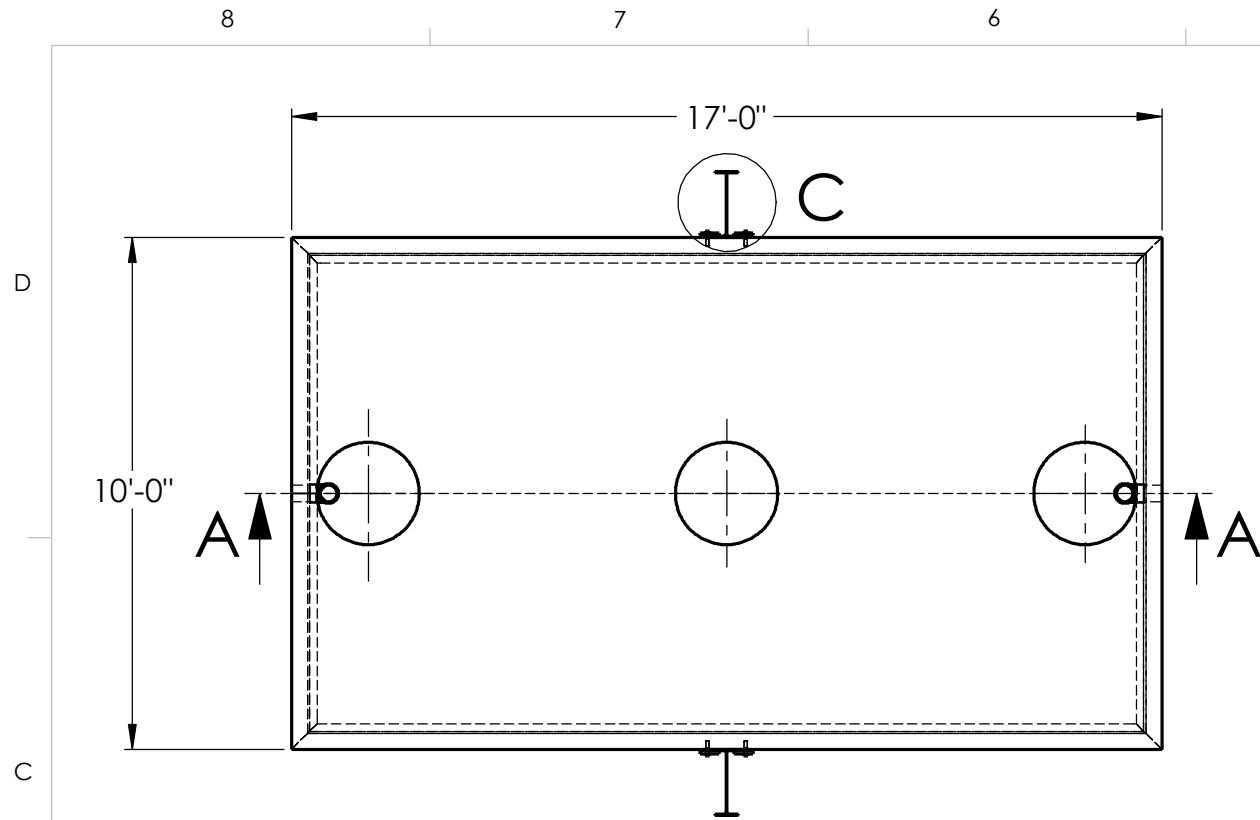
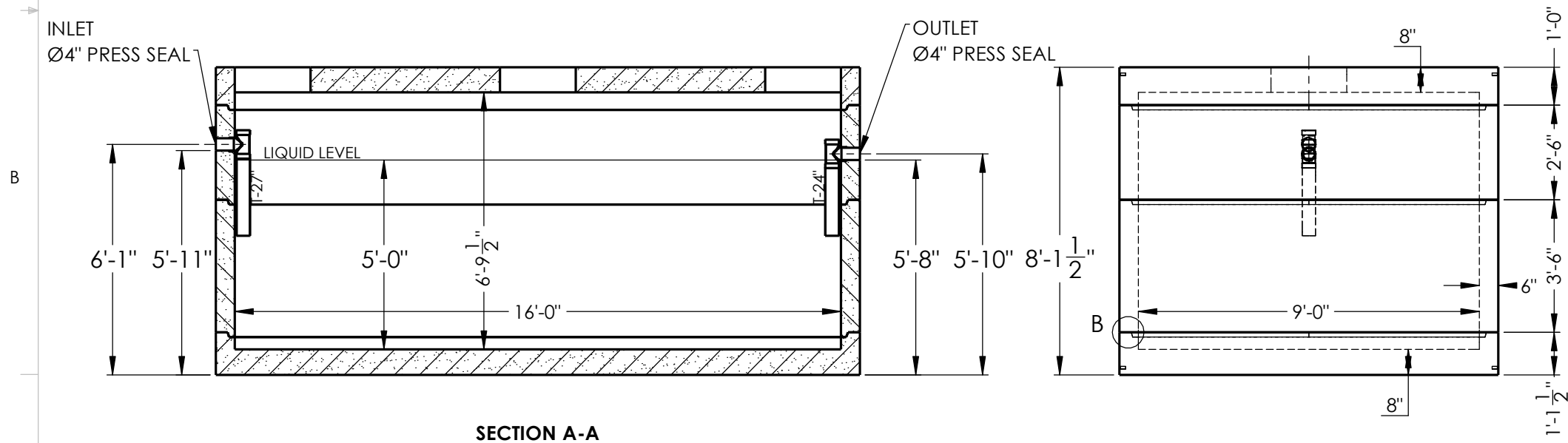

CONCRETE:

TANK CONSTRUCTION UTILIZES 6000 PSI CONCRETE AND GRADE 60 REBAR

GALLON CALCULATIONS:

9'-0" W x 16'-0" L x 5'-0" H x 7.48 = 5,385 GAL

NON-TRAFFIC RISERS:

PVC: 24" Ø & FIB. COVER (TO GRADE)
CONCRETE: 24" Ø x 8" OR 12" (6" BELOW GRADE)

TRAFFIC RISERS/COVERS:

24" Ø GRADE RINGS (2", 3", 4", 5", 6", 13")
4" x 24" Ø CAST-IRON GASKETED BOLT-DOWN

UPLIFT RINGS:

BURY DEPTH WITH WATER AT GRADE ~ 4"
BURY DEPTH WITH WATER AT TOP OF TANK ~ 2"

BEDDING:

4" PEA GRAVEL OR COMPACTED CRUSHED GRAVEL (NO WATER PRESENT)

EXCAVATION:

12" LARGER EACH WAY THAN TANK DIMENSION

BURY:

MAXIMUM BURY DEPTH ~ 3'

NOTES:

- 1077 GALLONS/VERTICAL FOOT CAPACITY
- ON-SITE CRANE SUPPLIED BY CONTRACTOR (20,000# PICK TO CENTER OF EXCAVATION)
- WIDE FLANGE INSTALL (IF REQ'D) BY CONTRACTOR.

NOTES:
REINFORCEMENT:
WALLS:
-#6 @ 6" O.C. HORIZONTAL
-#4 @ 10" O.C. VERTICAL
TOP & BOTTOM
-#6 @ 6" O.C. SHORT DIRECTION
#5 @ 12" O.C. LONG DIRECTION, (2) #5 BAR LONG SIDE OF ACCESS, (2) #6 BAR SHORT SIDE



2215 E. BROOKLYN AVE
SPOKANE, WA 99217
TOLL FREE 1-800-888-4573
(509) 325-4573 FAX (509) 325-5098
SPOKANE - LEWISTON - YAKIMA
www.wilbertprecast.com

DRAWN BY:
CEB

TITLE: 5000 GALLON SINGLE COMPARTMENT TANK TRAFFIC BEARING

SIZE B	DWG. NO. 916-5S	SCALE: NTS	DATE: 8/1/2019
------------------	---------------------------	----------------------	--------------------------