

WARRANTY: ALL TANKS MUST BE BACKFILLED AND COMPACTED PRIOR TO FILLING OR WARRANTY IS VOID.

CONCRETE:
TANK CONSTRUCTION UTILIZES 6000 PSI CONCRETE AND GRADE 60 REBAR

GALLON CALCULATIONS:
9'-0"W x 10'-4"L x 4'-0"H x 7.48 = 2,783 GAL
9'-0"W x 5'-2"L x 4'-0"H x 7.48 = 1,391 GAL

NON-TRAFFIC RISERS:
PVC: 24"Ø & FIB. COVER (TO GRADE)
CONCRETE: 24"Ø x 8" OR 12" (6" BELOW GRADE)

TRAFFIC RISERS/COVERS:
24"Ø GRADE RINGS (2",3",4",5",6",13")
4" x 24"Ø CAST-IRON GASKETED BOLT-DOWN

UPLIFT RINGS:
BURY DEPTH WITH WATER AT GRADE ~ 4'
BURY DEPTH WITH WATER AT TOP OF TANK ~ 2'

BEDDING:
4" PEA GRAVEL OR COMPACTED CRUSHED GRAVEL (NO WATER PRESENT)

EXCAVATION:
12" LARGER EACH WAY THAN TANK DIMENSION

BURY:
MAXIMUM BURY DEPTH ~ 5'

- NOTES:**
- 1043 GALLONS/VERTICAL FOOT CAPACITY
 - ON-SITE CRANE SUPPLIED BY CONTRACTOR (20,000# PICK TO CENTER OF EXCAVATION)

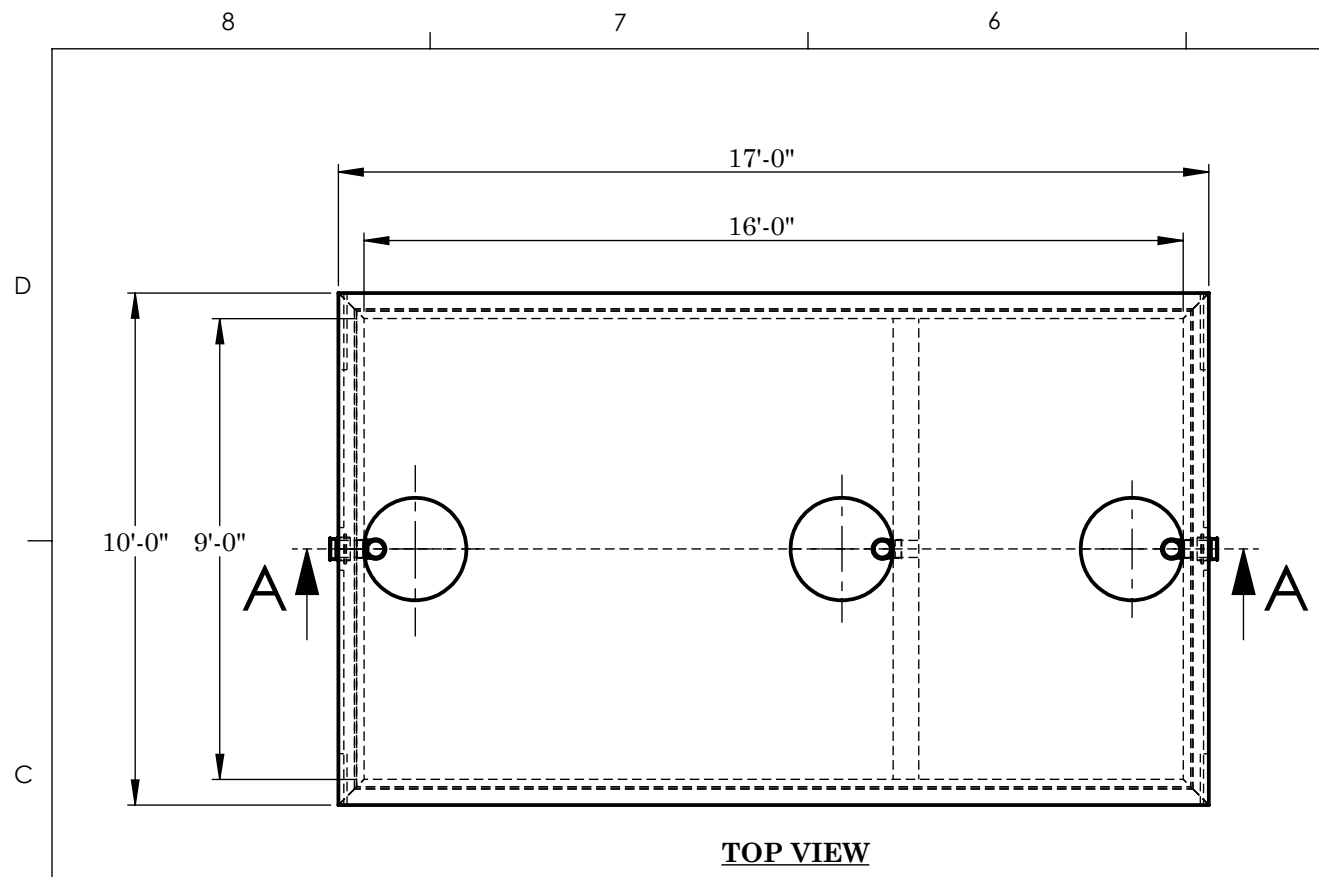

TOP VIEW

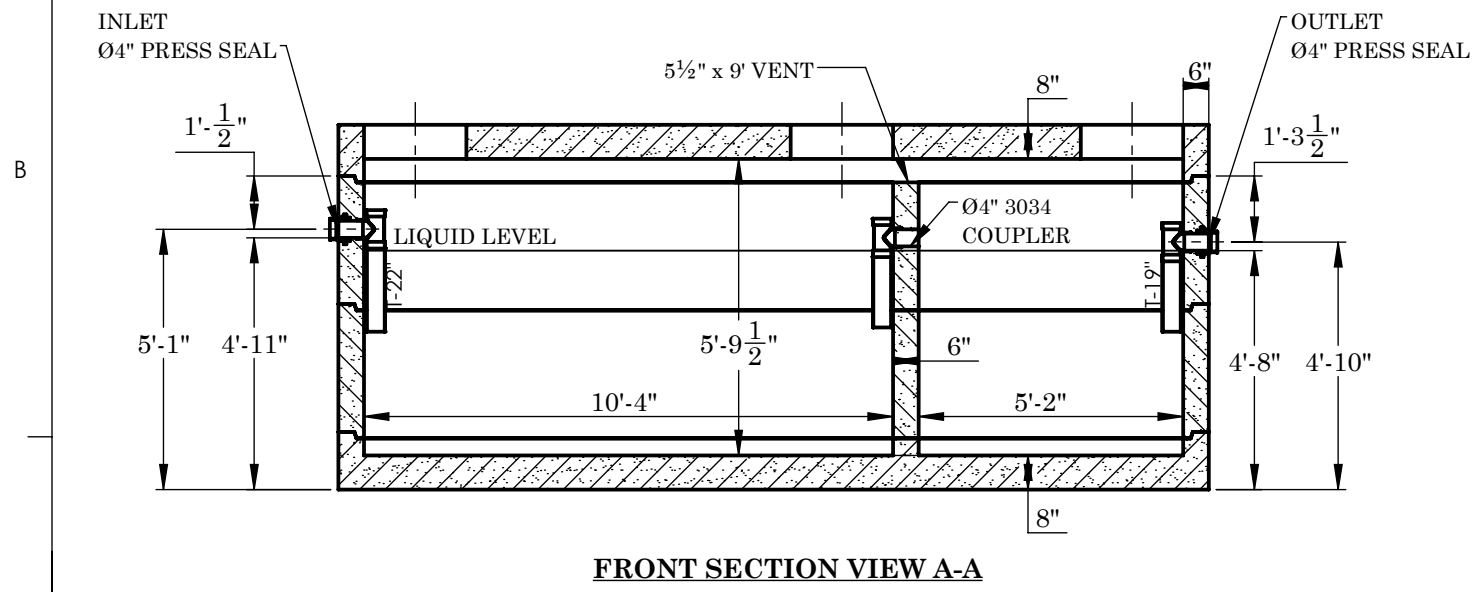
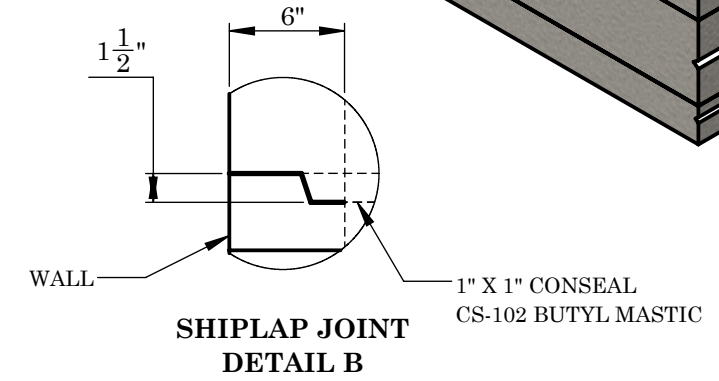
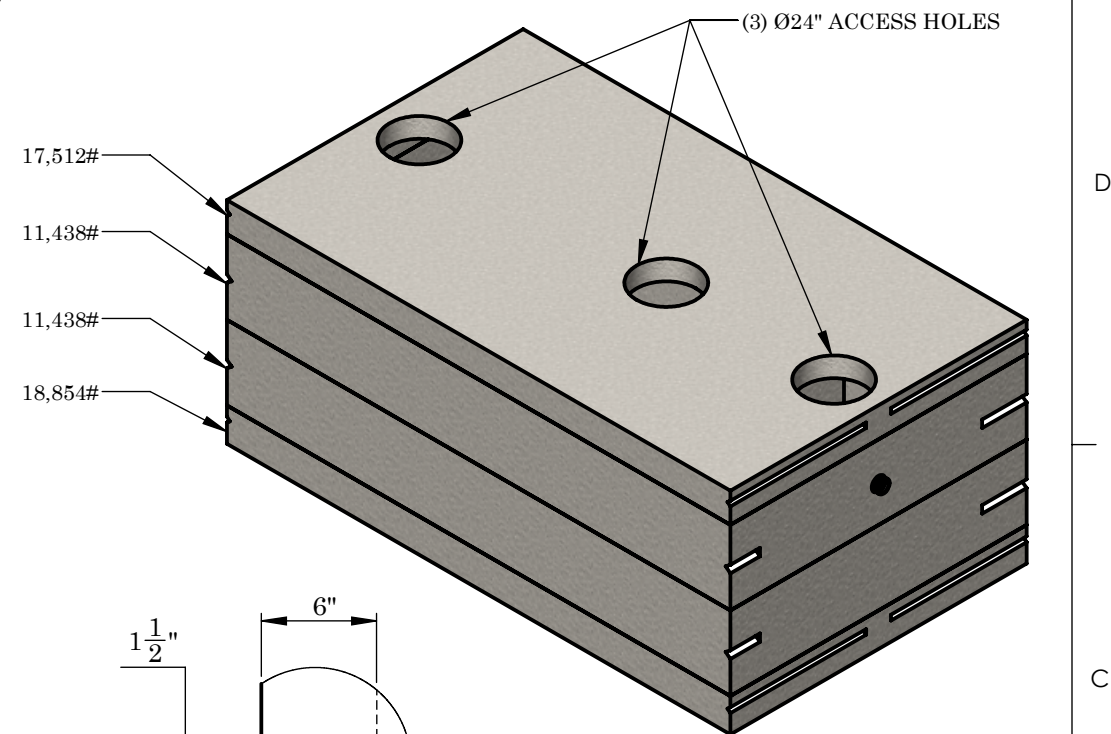

FRONT SECTION VIEW A-A

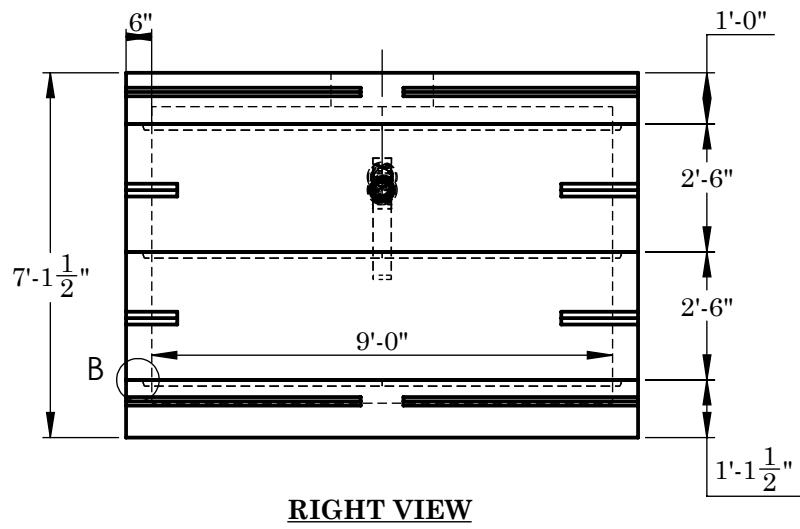

RIGHT VIEW

REINFORCEMENT:

WALLS:
#6 @ 6" O.C. HORIZONTAL
#4 @ 10" O.C. VERTICAL

TOP & BOTTOM
#6 @ 6" O.C. SHORT DIRECTION
#5 @ 12" O.C. LONG DIRECTION, (2) #5 BAR LONG SIDE OF ACCESS, (2) #6 BAR SHORT SIDE



**2215 E. BROOKLYN AVE
SPOKANE, WA 99217
TOLL FREE 1-800-888-4573
(509) 325-4573 FAX (509) 325-5098
SPOKANE - LEWISTON - YAKIMA
www.wilbertprecast.com**

TITLE: 3000 GALLON DOUBLE COMPARTMENT TANK TRAFFIC BEARING			
SIZE B	DWG. NO. 916-4D	SCALE: NTS	DATE: 6/29/2026

DRAWN BY:
TH